

1
A5.2 **Enlarged Plan**
Scale 1/4" = 1'-0"

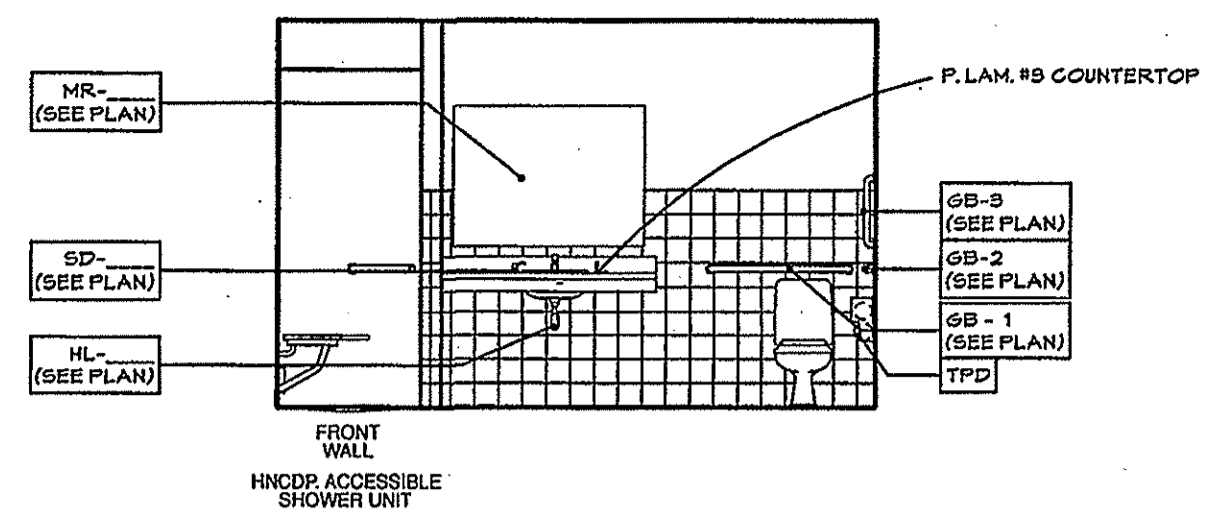

2
A5.2 **Interior Elevation**
Scale 1/4" = 1'-0"

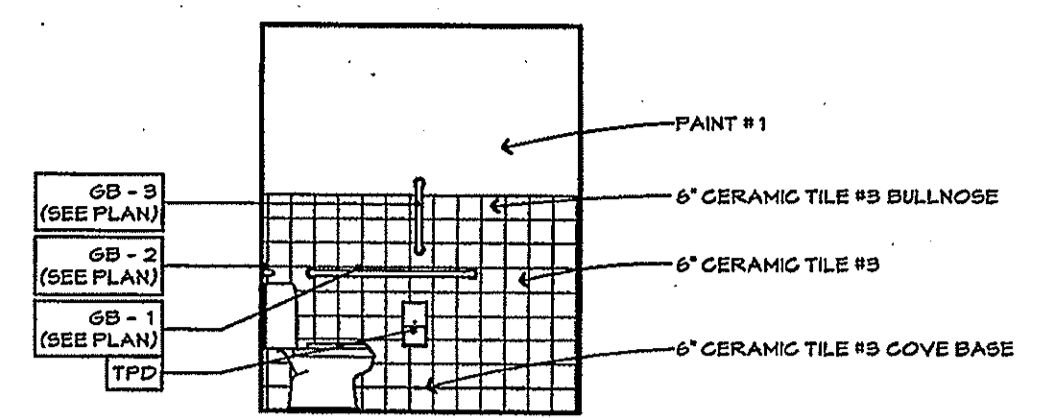

3
A5.2 **Interior Elevation**
Scale 1/4" = 1'-0"

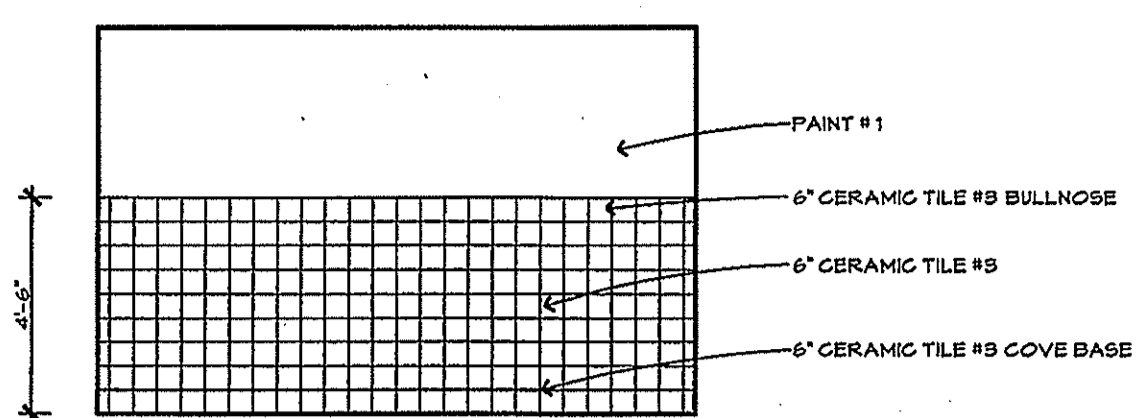

4
A5.2 **Interior Elevation**
Scale 1/4" = 1'-0"

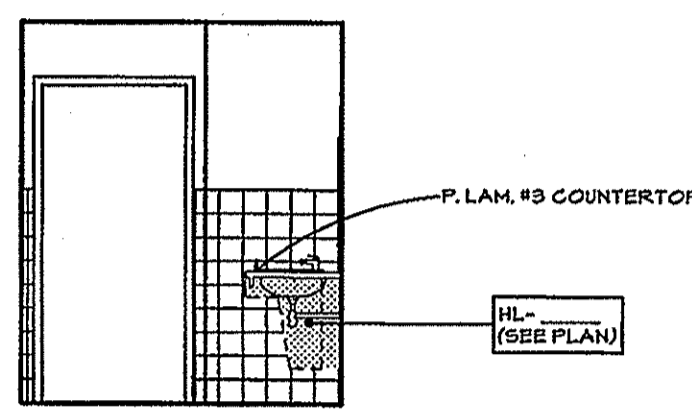

5
A5.2 **Interior Elevation**
Scale 1/4" = 1'-0"

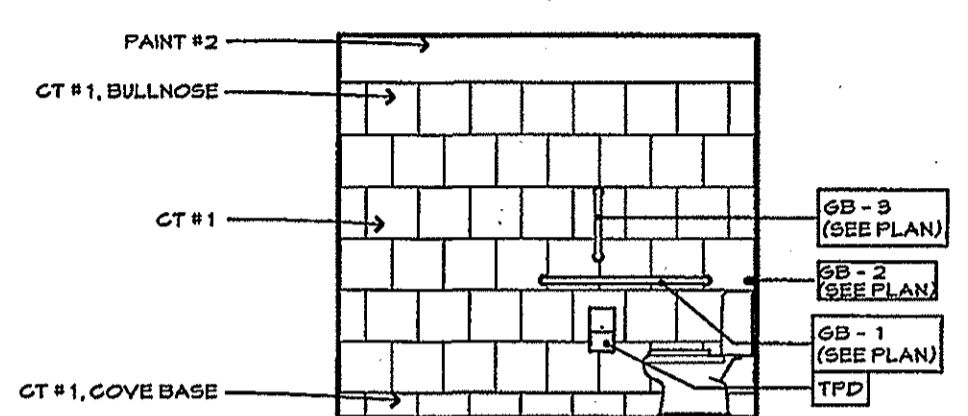

6
A5.2 **Interior Elevation**
Scale 1/4" = 1'-0"

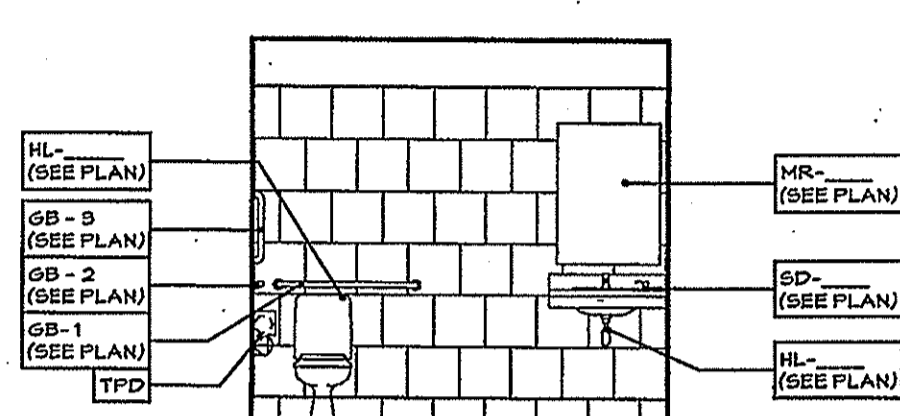

7
A5.2 **Interior Elevation**
Scale 1/4" = 1'-0"

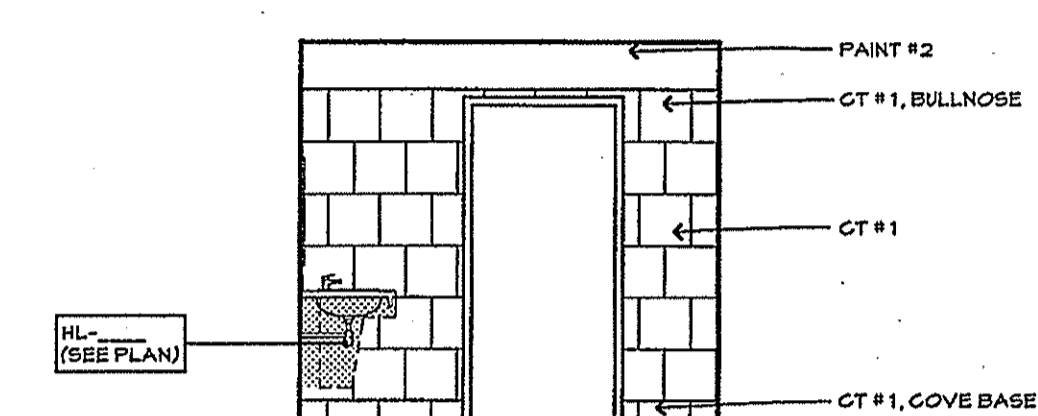

8
A5.2 **Interior Elevation**
Scale 1/4" = 1'-0"

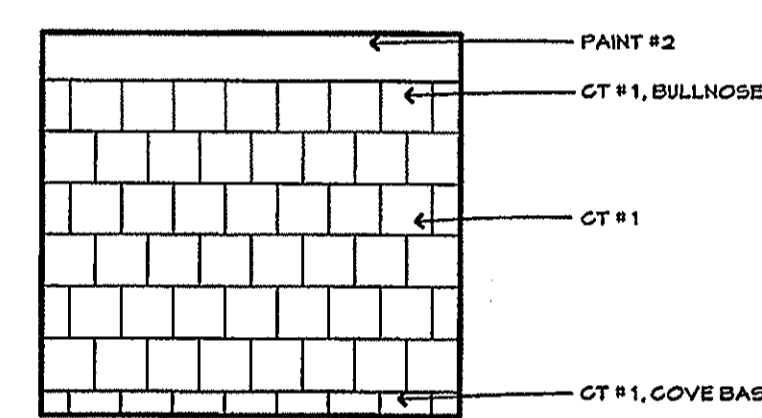

9
A5.2 **Interior Elevation**
Scale 1/4" = 1'-0"

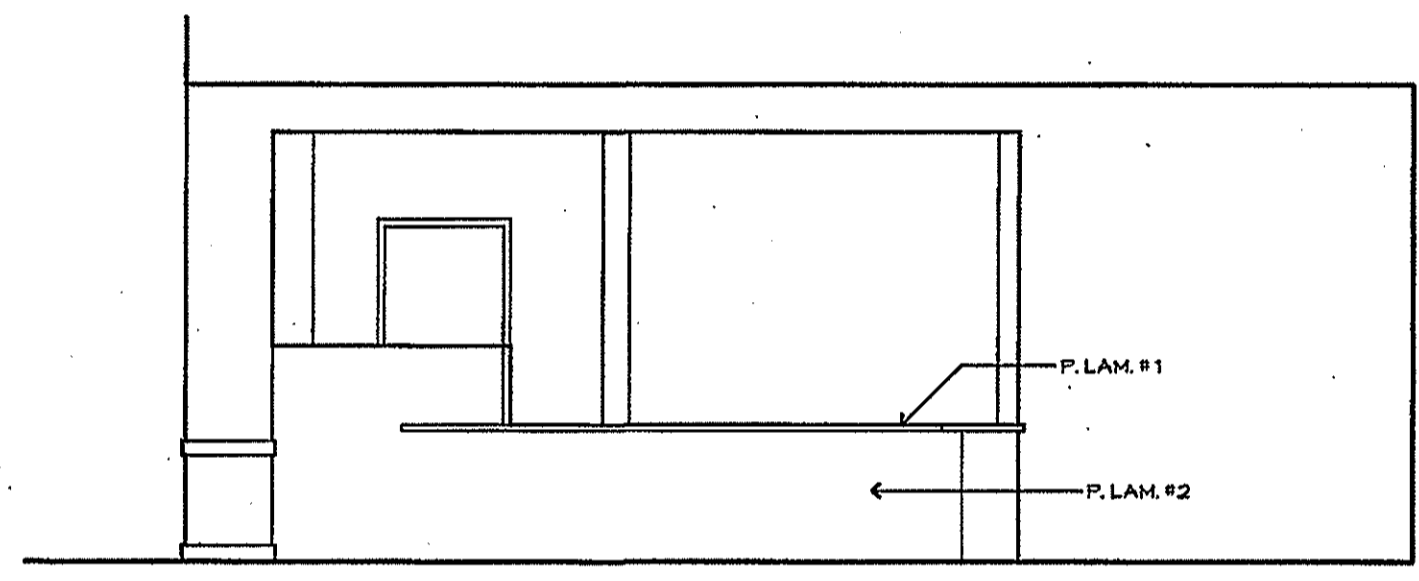

10
A5.2 **Interior Elevation**
Scale 1/4" = 1'-0"

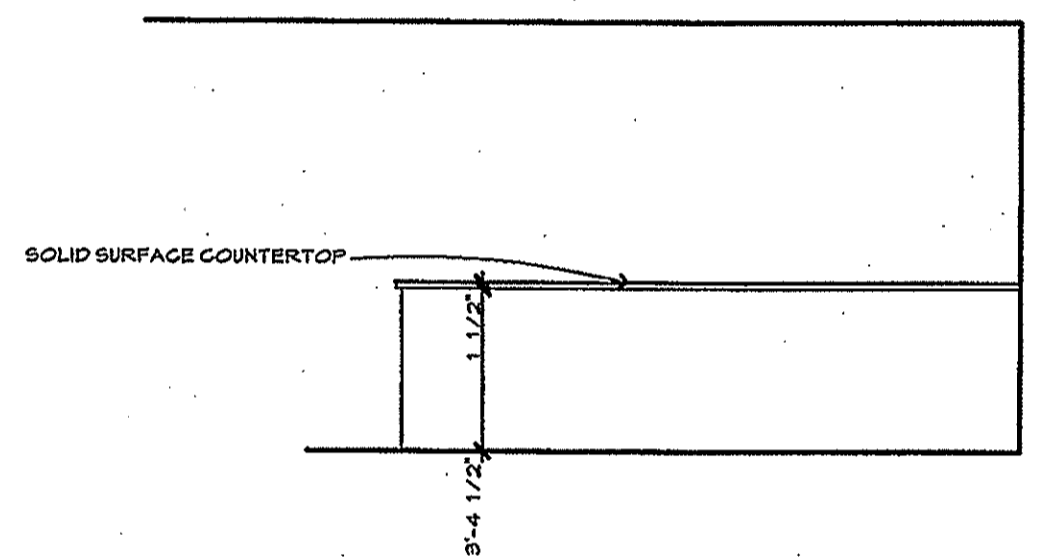

11
A5.2 **Interior Elevation**
Scale 1/4" = 1'-0"

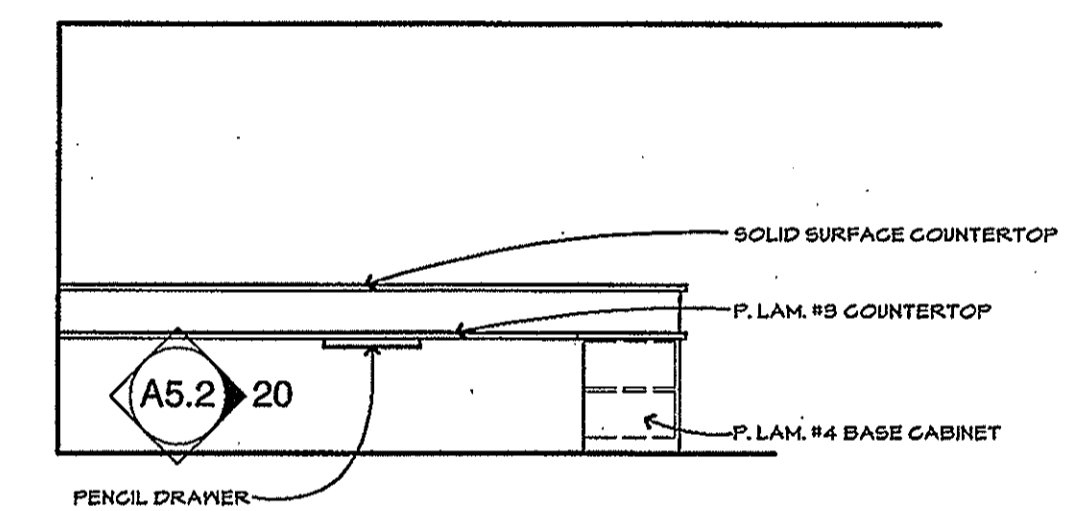

12
A5.2 **Interior Elevation**
Scale 1/4" = 1'-0"

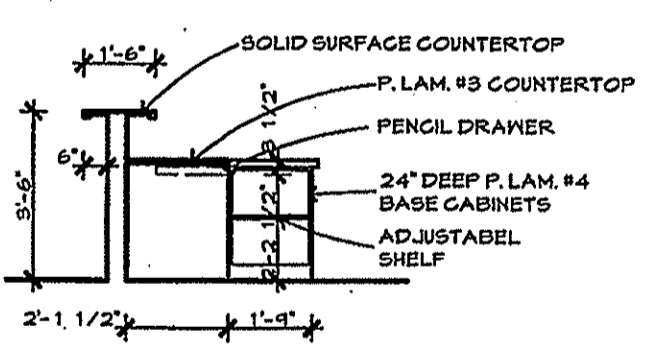

13
A5.2 **Interior Elevation**
Scale 1/4" = 1'-0"

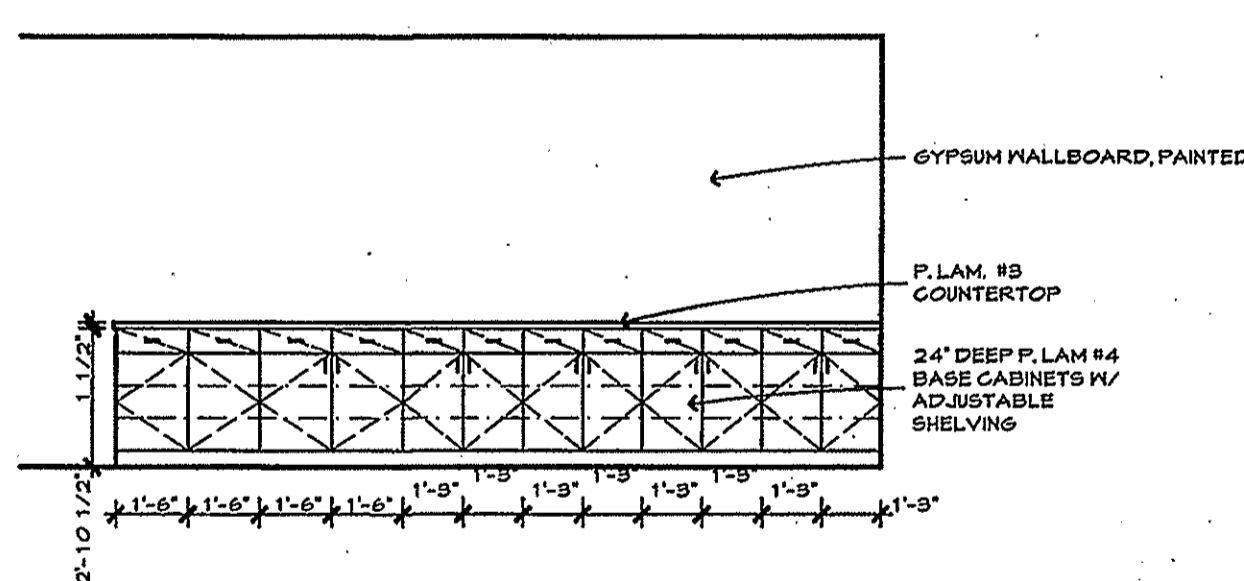

14
A5.2 **Interior Elevation**
Scale 1/4" = 1'-0"

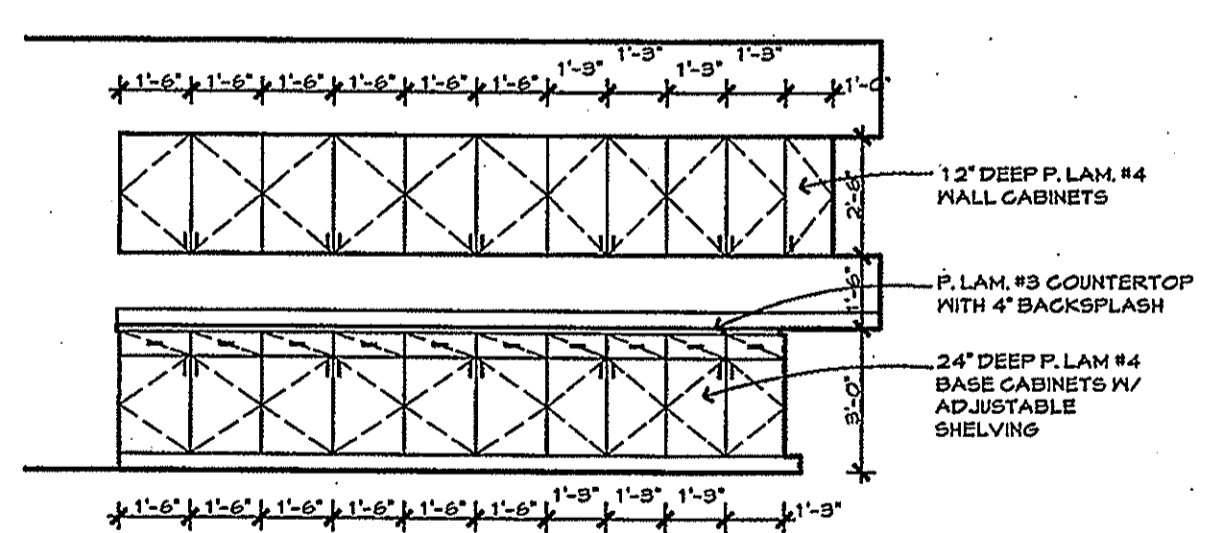

15
A5.2 **Interior Elevation**
Scale 1/4" = 1'-0"

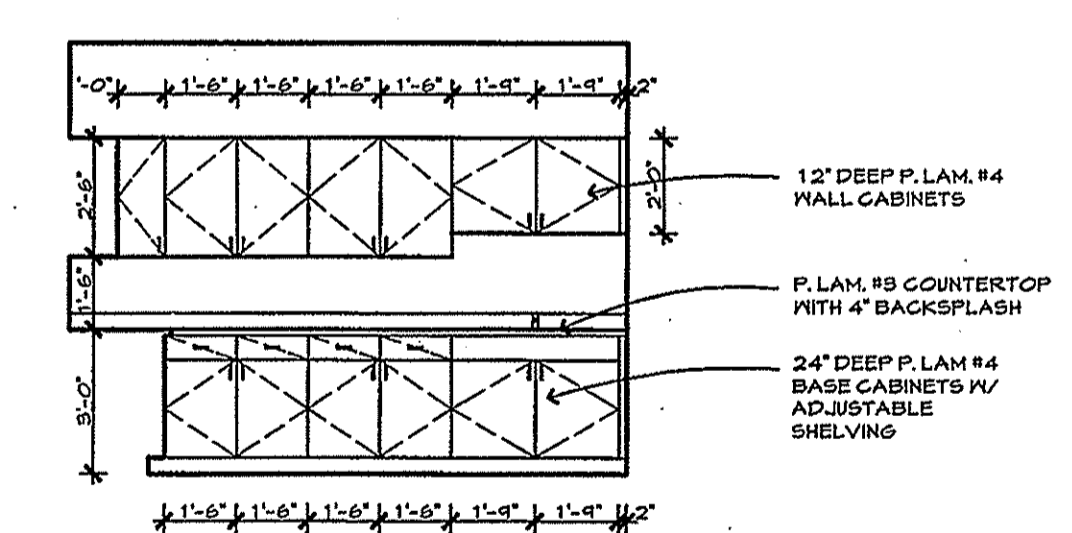

16
A5.2 **Interior Elevation**
Scale 1/4" = 1'-0"

Mount Olive
Assembly of God
14201 Cedar Avenue South
Apple Valley, MN 55124
952.432.4332

REVISION	DATE

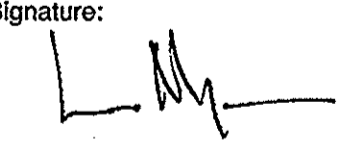
I hereby certify that this plan, specification, or report was prepared by me or under my direct supervision and that I am a duly Licensed Architect under the laws of the State of Minnesota.
Print Name: _____
Signature: 
Date: 2-13-2007 License No: 44402

Interior Elevations

COMM. NO.: 50714
SCALE: ---
DATE: FEBRUARY 13, 2007
DRAWN BY: ---

BID DOCUMENTS

A5.2